

# TEMPLE RUN™

## DANGER CHASE™

### INSTRUCTIONS

Ages 8 and Up • 2 to 4 Players

### CONTENTS

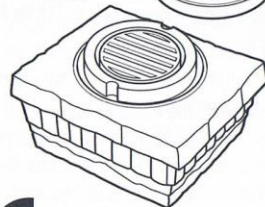
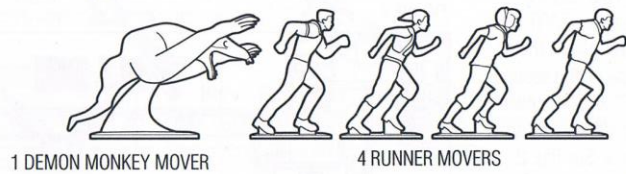
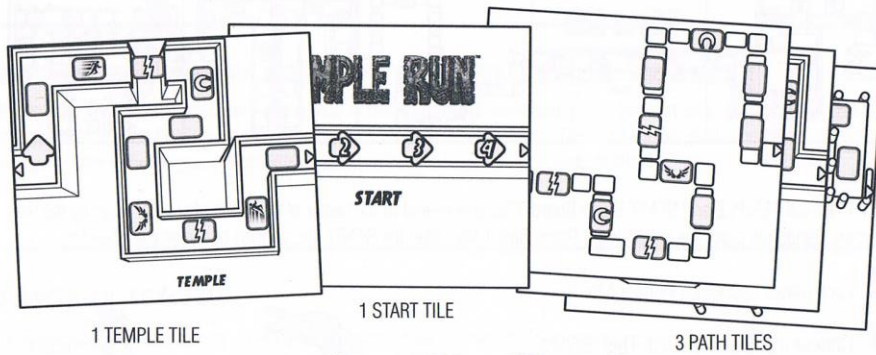

⚠ Warning: CHOKING HAZARD – Small parts.  
Not suitable for children under 3 years



## ASSEMBLE THE IDOL TIMER

Press the IDOL onto the IDOL BASE as shown.

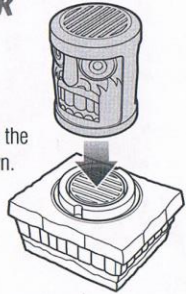

## SET DIFFICULTY

Move the LEVEL SWITCH on the side of the Idol Timer to the desired level of game difficulty. The easier the level, the more time you have during your turn. When you hear the drums, the Idol Timer is ready to play.

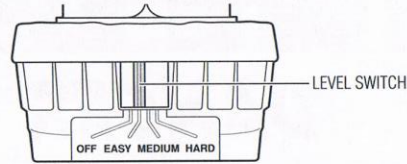

## SET UP

ELECTRONIC IDOL TIMER

POWERUP TOKENS

DICE

ALIGN ARROWS

FIGURE 1

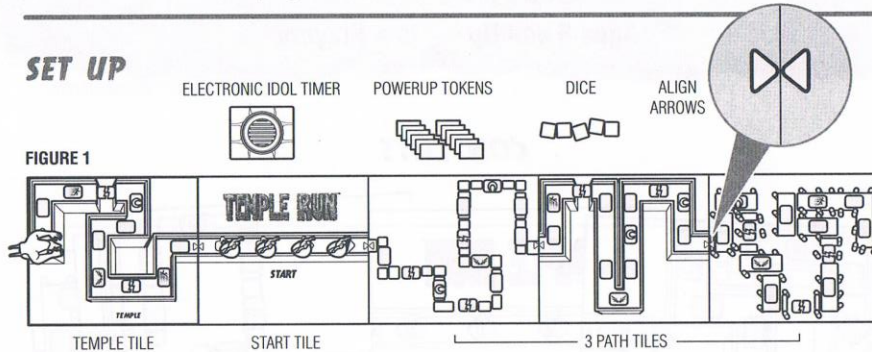

**1** Place the TEMPLE and START Game Board Tiles end-to-end in the center of the game play area, aligning the red arrows. Randomly place the remaining 3 Game Board Tiles after the START tile, aligned by the arrows. See Fig. 1.

**2** Each player chooses a Runner Mover.

**3** Choose a player to go first. This player's Runner goes on the "1" space on the START tile. Continuing clockwise, each player places their Runner on the next numbered space (the second player goes on "2," etc.). The "3" and "4" spaces may not have a Runner on them, depending on how many players are in the game. See Fig. 2.

**4** Place the Evil Demon Monkey Mover on the Monkey symbol space on the TEMPLE tile. See Fig. 2.

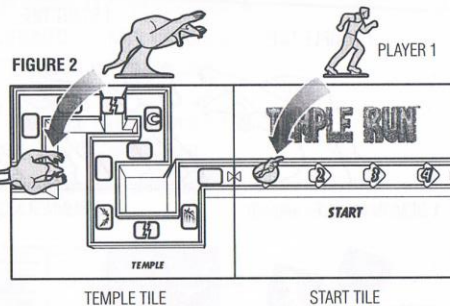

**5** Separate the Powerup Tokens into 2 piles (Blue and Yellow), and place them near the Game Board so that all players can reach them. This forms the Powerup Bank. Each player takes one blue "Resurrect" Powerup and one yellow "Boost" Powerup from the bank and places them in front of them.



BLUE "RESURRECT"  
POWERUP TOKENS



YELLOW "BOOST"  
POWERUP TOKENS

## QUICK START

### OBJECT

Outrun the Evil Demon Monkey and be the last Runner alive to win!

### HOW TO PLAY

Each turn follows this order:

**1** When you turn the Idol on, you'll hear a slow drum beat. **Press the Idol to start your turn.** The drums will beat faster during your turn.

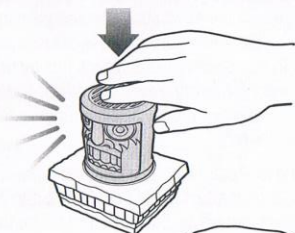

**2** Roll and reroll the dice until you want to stop. You can reroll Runner symbols and blanks, but you **CANNOT reroll Monkey symbols.**



**3** Press the Idol to stop your turn. If you hear the Demon Monkey screech, you've taken too long and must go to the back of the pack! See "The Idol Timer" on page 4.

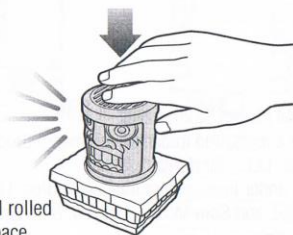

**4** Move your Runner one space for each Runner symbol rolled on the dice. Players cannot share spaces. If you land on a space occupied by another Runner, move ahead to the next open space.

- Try to avoid the red Obstacle spaces (see "Obstacle Spaces" on page 5)
- Try to land on a blue, yellow, or purple Powerup space (see "Powerup Spaces" on page 5)

**5** Move the Evil Demon Monkey one space for each Monkey symbol.

**6** Collect a Powerup token if you landed on a Powerup space.

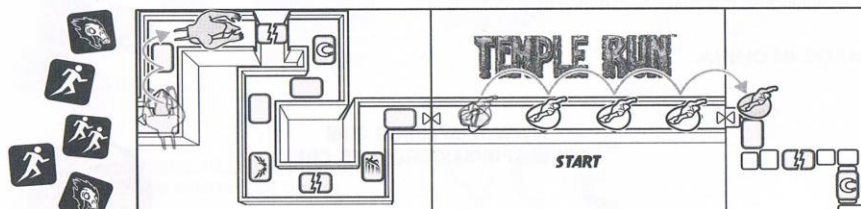

### WHAT THE DICE MEAN:

◆ Each RUNNER SYMBOL rolled is one space your Runner moves. Add up all the Runner Symbols rolled and move your Runner this number of spaces.



◆ Each MONKEY SYMBOL rolled is one space the Evil Demon Monkey moves. Add up all the Monkey Symbols rolled and move the Demon Monkey this number of spaces.



◆ A BLANK roll means nothing.

### REROLLING:

During your turn, you can reroll any or all the Runner or Blank symbols you want. **You CAN'T reroll a Demon Monkey symbol – once rolled, it's locked.**

### THE IDOL TIMER:

Your turn begins when you press the Idol Timer. The drums will beat faster, so start rolling! Once you're satisfied with your roll, press the Idol to stop the Timer.

◆ If you hear a cymbal, you've stopped in time. Move your Runner and the Demon Monkey the number of spaces as indicated by the dice.

◆ If you hear a "SPLAT" and the Demon Monkey screeching, you've taken too long! Do not move ahead — you must move your Runner back to the space immediately behind the last Runner on the board. If you're the last Runner, move your Runner back one space.

- After moving your Runner back, move the Demon Monkey the number of Monkey symbols you rolled. If the Demon Monkey catches a Runner, see "What if the Demon Monkey Catches You?" on page 5.

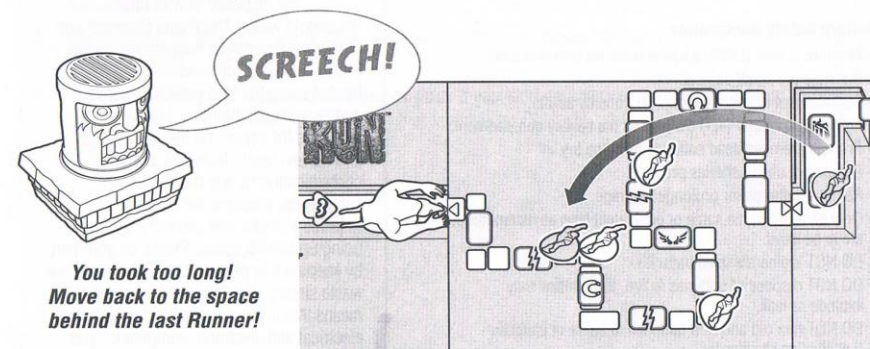

**NOTE:** As the game progresses, the amount of time you have before the Demon Monkey screeches gets shorter.

### WHAT IF THE EVIL DEMON MONKEY CATCHES YOU?

If the Demon Monkey moves onto or through the space occupied by your Runner, you've been eaten! Remove your Runner from the board and return any unused Powerup tokens to the bank. Now, it's your job to roll for the Demon Monkey! See "Roll for the Evil Demon Monkey," below.

**NOTE:** If the Demon Monkey catches more than one Runner during a turn, ALL of the caught Runners are out of the game. If the Demon Monkey catches all of the remaining players on the board during a turn, the Runner who was in the lead wins the game.

---

### OBSTACLE SPACES:

If you end your turn on a red Obstacle Space, you're dead! Remove your Runner from the board and return any unused Powerup tokens to the bank. Players who have been eliminated get to roll for the Evil Demon Monkey.



**NOTE:** The Evil Demon Monkey is NOT affected by Obstacle spaces.

---

### OUT OF THE GAME? ROLL FOR THE EVIL DEMON MONKEY

When your Runner has been eliminated, you're not completely out of the game. Now on each of your turns you can roll all five dice ONCE and move the Demon Monkey the number of Demon Monkey symbols rolled. Do not press the Idol to begin and end your turn when rolling for the Demon Monkey.

---

### POWERUP SPACES:

When you land on a blue or yellow Powerup space, take a Powerup Token of that color from the bank. Here's how to use Powerup tokens:



◆ **Blue "Resurrect" Powerup:** When you land on an Obstacle space, use this token to keep yourself in the game. Once used, return the Resurrect token to the bank. Your Runner stays on the Obstacle space.



◆ **Yellow "Boost" Powerup:** This Powerup DOUBLES the number of Runner icons you roll, and must be played BEFORE you begin rolling. Announce to the other players that you're using your Boost Powerup, return the token to the bank, then start the IDOL TIMER. At the end of your roll, move your Runner DOUBLE the total Runner icons rolled. Do NOT double the Monkey's dice roll. You may only use one "Boost" token per turn.

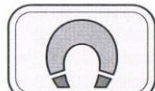

◆ **Purple "Magnet" Space:** When you land on a Purple Magnet space, you get to take one Powerup token from any other player. If none of the other players have a token, do nothing.

## THE ENDLESS PATH GAME BOARD:

The five Game Board Tiles are designed to form a continuous path. Once the Demon Monkey leaves the first Game Board Tile, flip over that tile and place it at the end of the last board to continue the path. As the game progresses, flip over each tile as soon as the Demon Monkey leaves that tile.

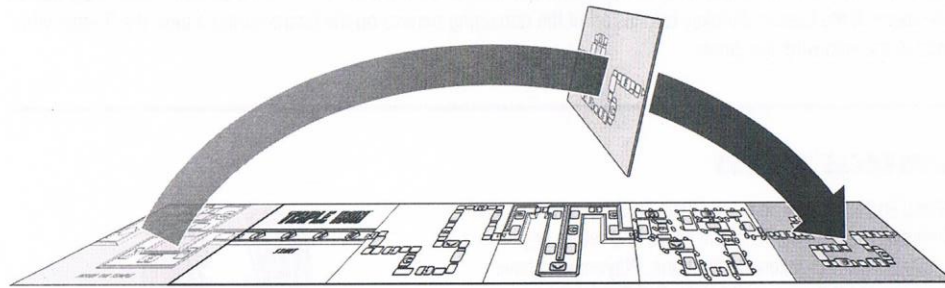

Double-sided game boards flip over and move, so there's always more path ahead!

**NOTE:** If your Runner makes it to the end of the fifth tile before the Demon Monkey leaves the first tile, move the Demon Monkey to the first space on the second tile, then flip over the first tile and move it to the end of the path. Regular Demon Monkey rules apply; see "What if the Evil Demon Monkey Catches You?"

## WINNING

The last Runner left on the board is the winner. You've survived the Evil Demon Monkey!

**Remember:** Always move the Runners first, then the Evil Demon Monkey. If the Demon Monkey eliminates all the remaining Runners on the board during a turn, the last Runner to be eliminated is the winner.

## HINTS AND TIPS

- ◆ **Look before you roll.** Count how many Runner symbols you need before you roll to avoid an Obstacle ahead.
- ◆ **Don't forget to Boost!** The Evil Demon Monkey sometimes moves fast. Keep your distance by using your Boost Powerup to move quickly ahead!
- ◆ **Pay attention to the Runners in front of you.** If you land on a space occupied by another Runner, you must move ahead to the next open space. If that space is an Obstacle, you may have just taken yourself out of the game!

## BATTERY REMOVAL AND INSTALLATION INSTRUCTIONS

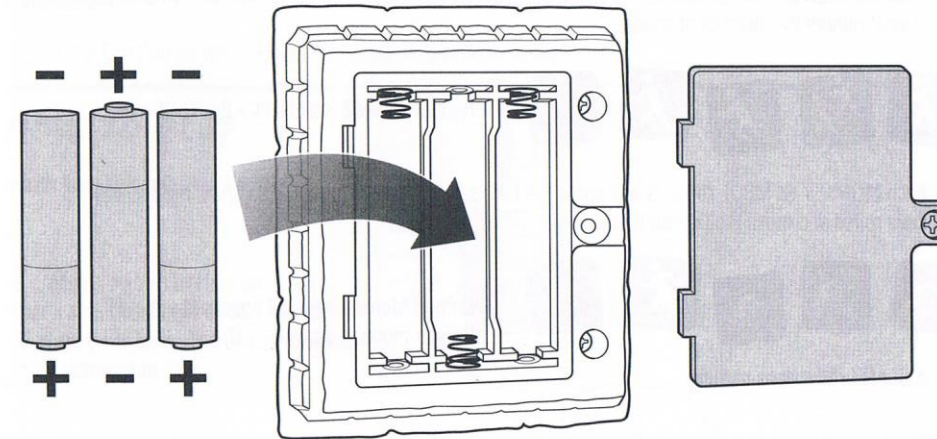

- 1** Open the battery door with a screwdriver (not included).
- 2** If used or spent batteries are present, remove these batteries from the unit by pulling up on one end of each battery. Install 3 new AAA (LR03) batteries as shown in the polarity diagram (+/-) inside the battery compartment.
- 3** Replace battery door securely.  
Check your local laws and regulations for correct recycling and/or battery disposal.

**Trouble Shooting:** If normal function of the product is disturbed or interrupted, strong electro-magnetic interference may be causing the issue. To reset product, turn it completely off, then turn it back on. If normal operation does not resume, move the product to another location and try again. To ensure normal performance, change the batteries, as low batteries may not allow full function.

### Battery Safety Information

- Requires 3 AAA (LR03) alkaline batteries (not included).
- Batteries are small objects.
- Replacement of batteries must be done by adults.
- Follow the polarity (+/-) diagram in the battery compartment.
- Promptly remove dead batteries from the toy.
- Dispose of used batteries properly.
- Remove batteries for prolonged storage.
- Only batteries of the same or equivalent type as recommended are to be used.
- DO NOT incinerate used batteries.
- DO NOT dispose of batteries in fire, as batteries may explode or leak.
- DO NOT mix old and new batteries or types of batteries (i.e. alkaline/standard).



Requires 3 AAA (LR03) batteries not included. Batteries must be recycled or disposed of properly. When this product has reached the end of its useful life it should not be disposed of with other

household waste. The Waste Electrical and Electronic Equipment Regulations require it to be separately collected so that it can be treated using the best available recovery and recycling techniques. This will minimize the impact on the environment and human health from soil and water contamination by any hazardous substances, decrease the resources required to make new products and avoid using up landfill space. Please do your part by keeping this product out of the municipal waste stream! The "wheelie bin" symbol means that it should be collected as "waste electrical and electronic equipment." you can return an old product to your retailer